

Tombstone Vise Horizontal Machining

WORKHOLDING

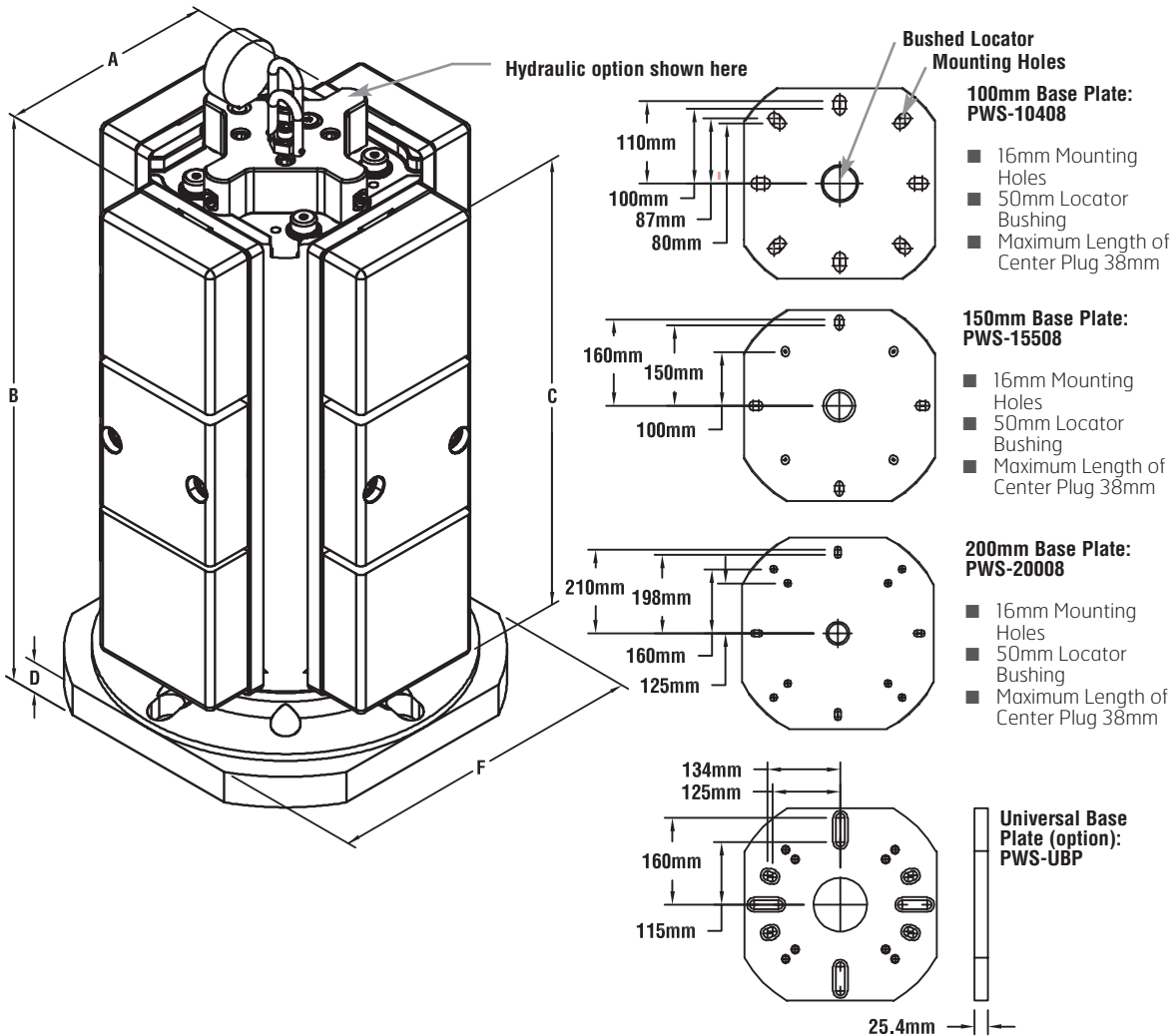

Part Number	Size (mm)	Weight (lbs.)	A (mm)	B (mm)	C (mm)	D (mm)	E (mm)	F (mm)	Max. Clamping Pressure	Maximum Pressure (PSI)
PWS-10408	100	159	175.80	454.03	398.00	25.40	150.50	254.00	6,000 lbs.	—
PWS-10408H*	100	159	175.80	490.43	398.00	25.40	150.50	254.00	5,000 lbs.	5,400 input pressure
PWS-15508	150	297	241.42	576.88	498.86	44.50	196.75	355.60	11,000 lbs.	—
PWS-15508H*	150	297	241.42	612.98	498.86	44.50	196.75	355.60	10,000 lbs.	5,400 input pressure
PWS-20008	200	550	294.48	770.00	670.00	58.20	247.39	480.00	16,000 lbs.	—

DIMENSIONS

Description	100mm Vise	150mm Vise	200mm Vise
A – Between towers	85mm (3.4")	112mm (4.4")	147.3mm (5.8")
B – Max. Double-station	180mm (7.1")	225mm (8.9")	292.1mm (11.5")
C – Max. Single-station	380mm (15")	480mm (18.9")	645.2mm (25.4")

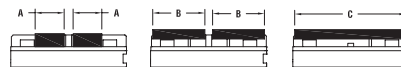

CAPACITY

* Hydraulic option.

Part numbers in **bold face** are in-stock items.

Tombstone Vise

Horizontal Machining

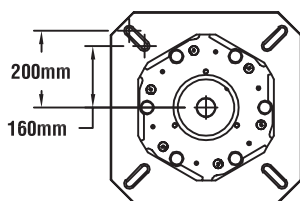
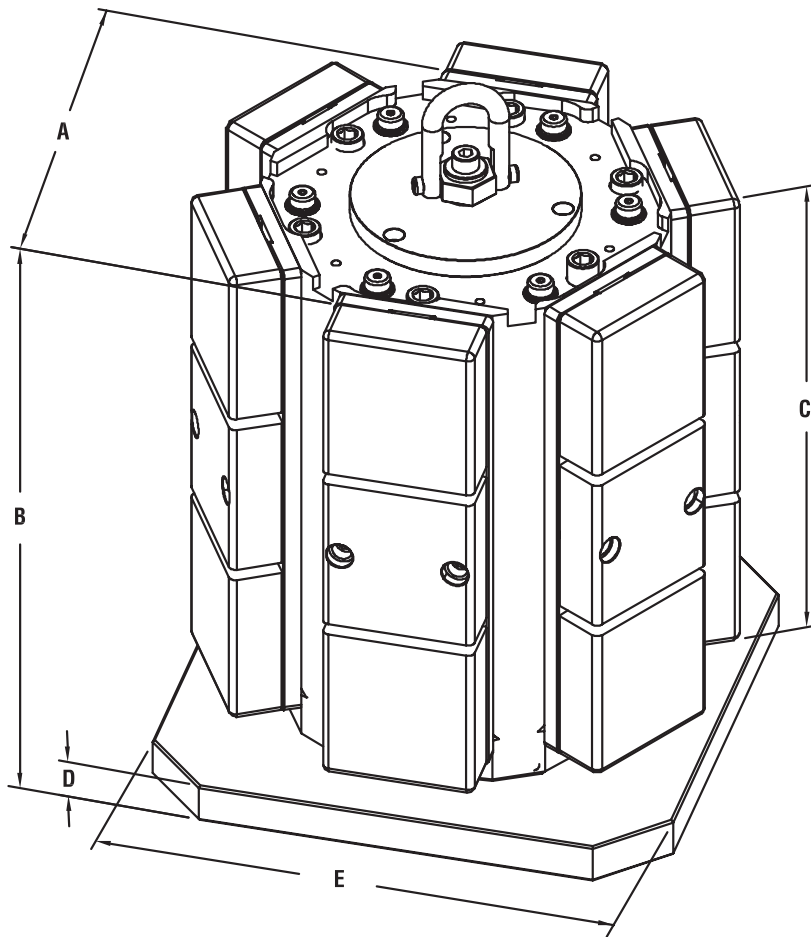

150mm Base Plate:
PWS-15512

- 16mm Mounting Holes
- 50mm Locator Bushing
- Maximum Length of Center Plug 38mm

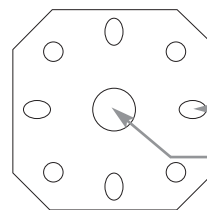

Mounting Holes

Bushed Locator Hole

Part Number	Size	Weight	A	B	C	D	E	Max. Clamping Force
PWS-15512	150mm	711 lbs.	390.64mm	571.50mm	498.86mm	38.10mm	500.00mm	11,000 lbs.

DIMENSIONS

Description	150mm Vise
A – Between towers	112mm (4.4")
B – Maximum Double-station	225mm (8.9")
C – Maximum Single-station	480mm (18.9")

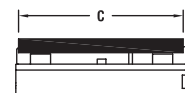
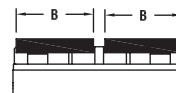
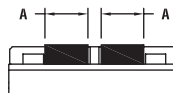

CAPACITY

Part numbers in **bold face** are in-stock items.